

PROFILE



INKA

INDEX

I. INTRODUCTION	Page 3
II. SCOPE OF WORK.....	Page 4
III. OUR PRODUCTS.....	Page 5
IV. OUR SERVICES.....	Page 11
V. OUR PARTNERS.....	Page 12
VI. OUR PROJECTS	Page 13
VII. OUR CUSTOMERS.....	Page 16

I INTRODUCTION

ABOUT US

Lin Ka Services Co. Ltd, specialized in supplying equipment and solutions for HVAC system, Indoor Environment, Blast Protection, Energy Saving. We have been optimizing and developing innovative solutions and applications annually. Our specialist team help customers consult and supply equipment for demand projects, Lin Ka Services Co. Ltd is more than a trading company, we care passionately about high quality services and products for customers.

OUR GOAL

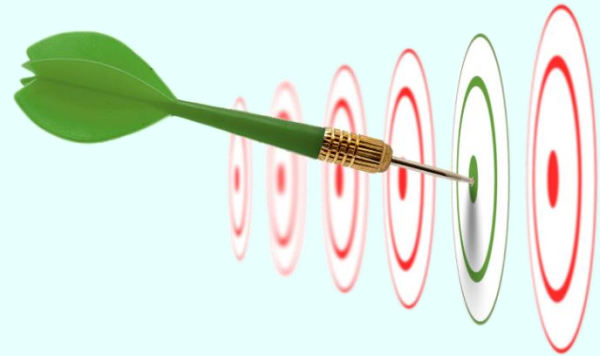

Let our client be taken good care of the best service of HVAC system, indoor environment, energy saving and protective solution.

ORGANIZATIONAL CHART



OUR MISSION

LINK WORLDWIDE
ADD VALUE

CONSULTANCY

- ❖ GUIDANCE
- ❖ ADVICE
- ❖ SUPPORT
- ❖ ASSISTANCE



TRADING

- ❖ PRODUCTS
- ❖ SERVICES



MAINTENANCE

- ❖ AFTER-SALES SERVICES
- ❖ REPAIR/ RESTORE
- ❖ REPLACE



III OUR PRODUCTS

WE SAVE YOUR ENERGY

Seibu Giken Total heat exchanger series



With Holtop Energy recovery ventilation unit



- ❖ Energy recovery
- ❖ Floor standing type
- ❖ Suspended type
- ❖ Airflow range: 150-15.000 m³/h
- ❖ Quiet operation
- ❖ Innovative access space design

And Holtop Cross flow plate heat exchanger

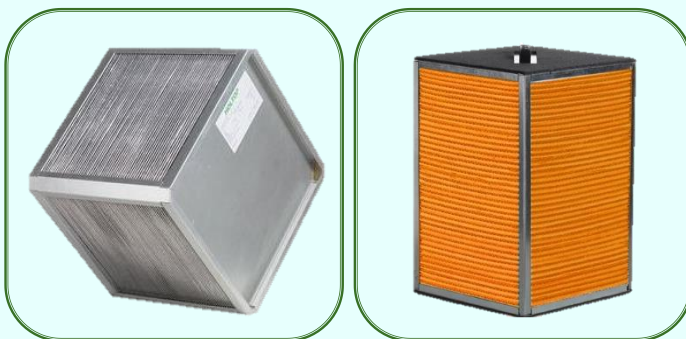

- ❖ High efficiency
- ❖ Total separation of fresh air and exhaust air stream
- ❖ Robust design
- ❖ Anti-bacteria and mold prevent

OUR PRODUCT QUALIFIED BY



WE HELP CONTROL YOUR INDOOR ENVIRONMENT



With Condair wide range of humidifier



Electrode boiler
Steam humidifier



Live Steam humidifier



Compressed air
& water spray humidifier



Resistive Steam humidifier



ME series (Evaporative)



US series (Ultrasonic)

- ❖ Energy efficiency
- ❖ Hygienic solution
- ❖ Robust design
- ❖ World class products and services
- ❖ Advise and support professionally
- ❖ Maximize and sustain ROI
- ❖ Improve health and wellbeing with humidity control

And Condair dehumidifier



Condensing dehumidifier



Desiccant dehumidifier



Swimming pool
dehumidifier



Visit us at www.condair.vn

With Halton Marine HVAC solutions



PCL Central vacuum cleaner

Number of simultaneous users	2	3	6	12
Nominal motor power	5,0 kW	5,5 - 6,3 kW	12,5 - 14,5 kW	25 - 29 kW
Max. air volume	400 m³/h	500 - 630 m³/h	1000 - 1200 m³/h	2000 - 2400 m³/h
Trunk pipe	2 x Ø50 mm	Ø75 mm	Ø110 mm	Ø160 mm / 2 x Ø110mm
Exhaust pipe	Ø110 - 125 mm	Ø125 mm	Ø125 - 160 mm	Ø160 mm / 2 x Ø110 mm
Max. pipe length to last inlet	50 - 125 m	125 m	160 - 200 m	160 - 200 m
Automatic pipe flushing	Optional with Ø75 mm trunk pipe	Yes	Yes	Yes
Automatic filter cleaning	No	Yes (pressure shock)	Yes (pressure shock)	Yes (pressure shock)
Option for separate vacuum and filtration units	Optional	Optional	Optional	Standard



Halton kitchen grease hood series



Marine external louvre



Fire & Gas damper



Droplet separator

- ❖ Robust steel
- ❖ Onshore and offshore application
- ❖ Anti-corrosion
- ❖ Long life cycle products
- ❖ Innovation technology



Contact us for support and consultancy

With LIFA air purification expert

LIFAair®



HEPA clean Negative Pressure Unit (NPU) machines

- ❖ 3G filtration technology
- ❖ Effectively collect particles, gaseous contaminants and organic compounds
- ❖ Massive dust holding capacity
- ❖ Very low pressure drops and energy consumption

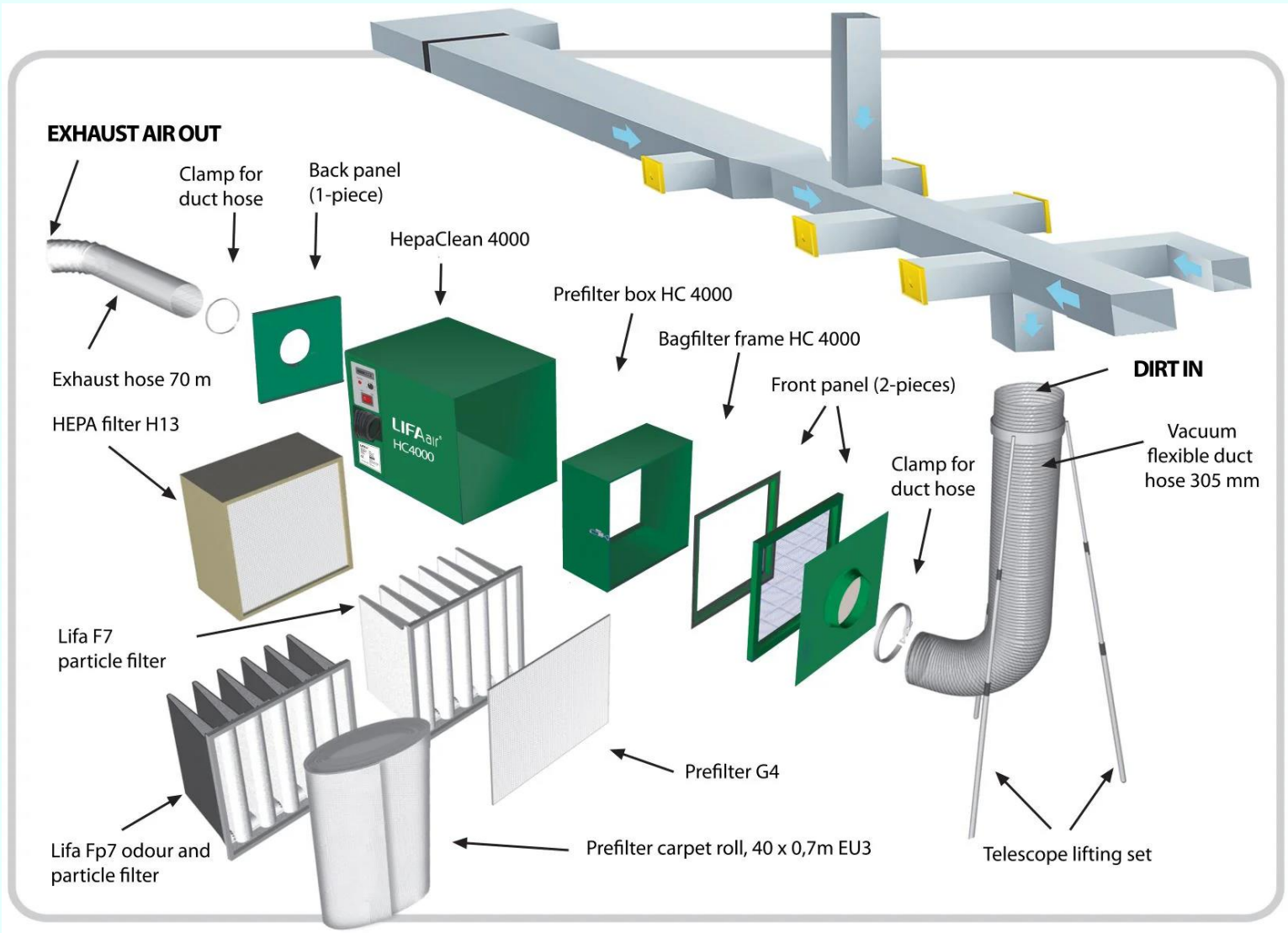

With Expansion-Electronics filtration solutions

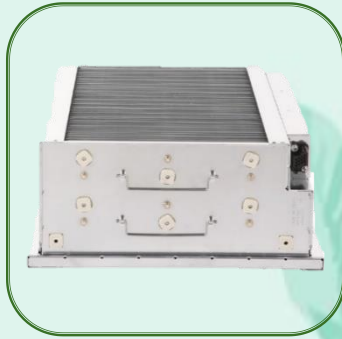
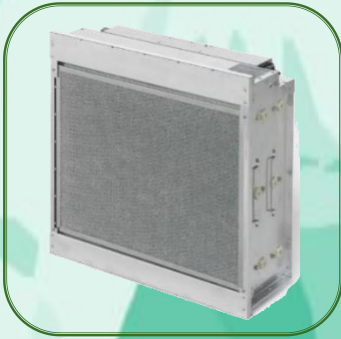

Electrostatic filters



Residential UC 1200 series



Residential Prolife series



Exhaust filtration unit
Ecokitchen model

- ❖ CO² emission reduction
- ❖ Health improvement
- ❖ Energy saving
- ❖ Regenerable and recyclable material
- ❖ Retrofit
- ❖ Sustainable product
- ❖ High efficiency particulates air filter
- ❖ High germicide power
- ❖ Easy maintenance
- ❖ Application in AHUs, rooftops, ventilation ducts

WE PROTECT AND PREVENT EXPLOSION

With TEMET solutions

TEMET

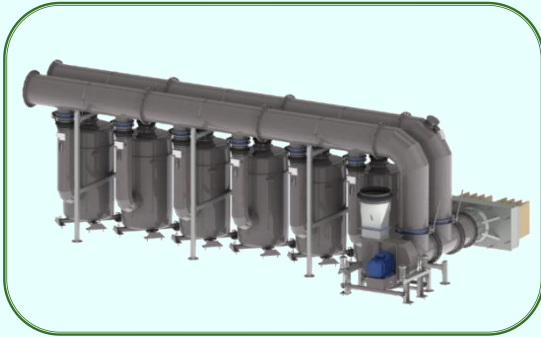

ESL series CBRN Filtration Units



ES-150 CBRN-filter



Custom designed blast door



Blast valve model PV-KK



Blast valve model HV

- ❖ Protect human life and property against Blast & CBRN threats.
- ❖ Customized as your needs.
- ❖ Provide professional advice.
- ❖ Quality guaranteed.

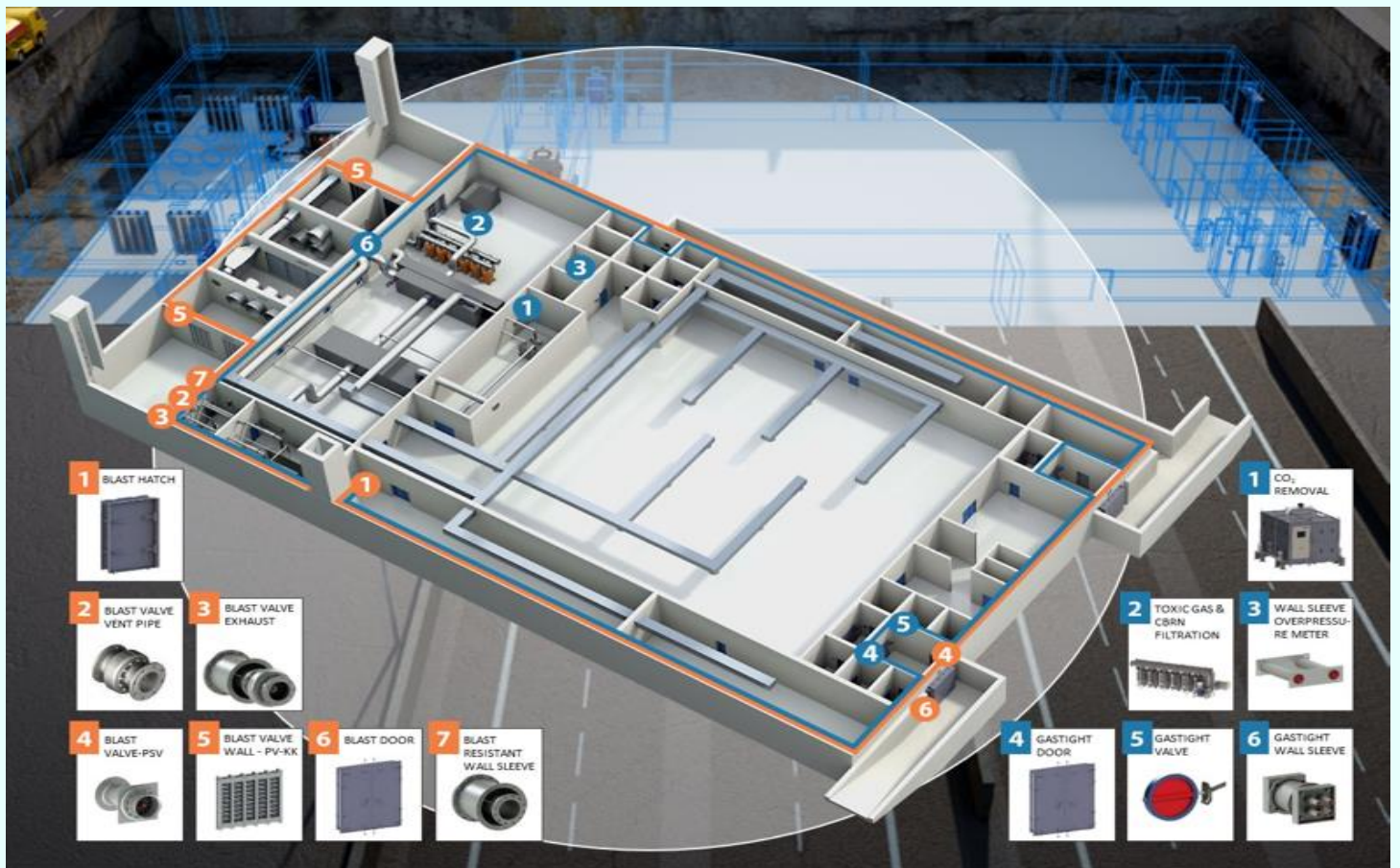

With RSBP dust explosion protection solutions

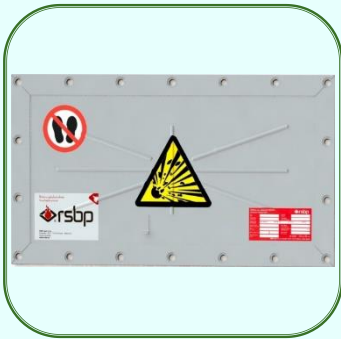

Explosion vent panel

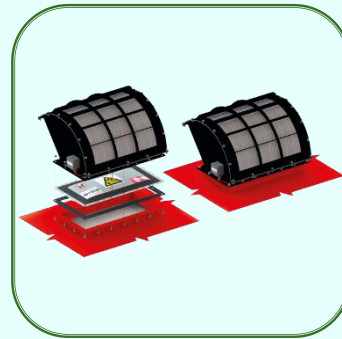
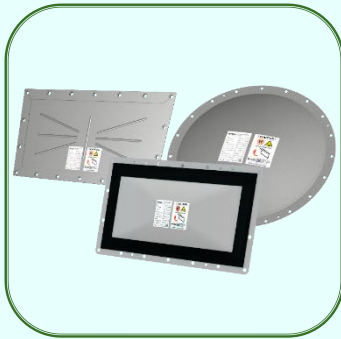

FLEX PRO®

Explosion flameless vent

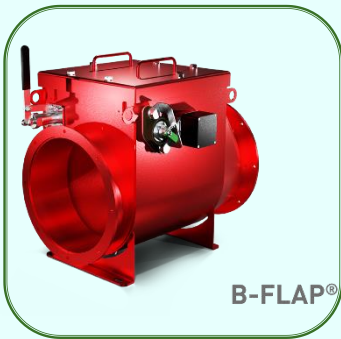

Isolation valve



Suppression system

- ❖ Reducing risk of damage and loss in production.
- ❖ Increasing occupational safety and protecting human health and lives.
- ❖ Protection of property and expensive technologies.
- ❖ Eliminating long downtimes, retaining existing customers, and maintaining economic stability.

EXPLOSION PROTECTION COMPONENTS

- A. B-Flap I - explosion isolation flap valve
- B. HRD container unit
- C. HRD barrier
- D. CONEX control unit
- E. LumEx - optical explosion detector
- F. FLEX R or VMP explosion venting device
- G. DetEx - pressure detector

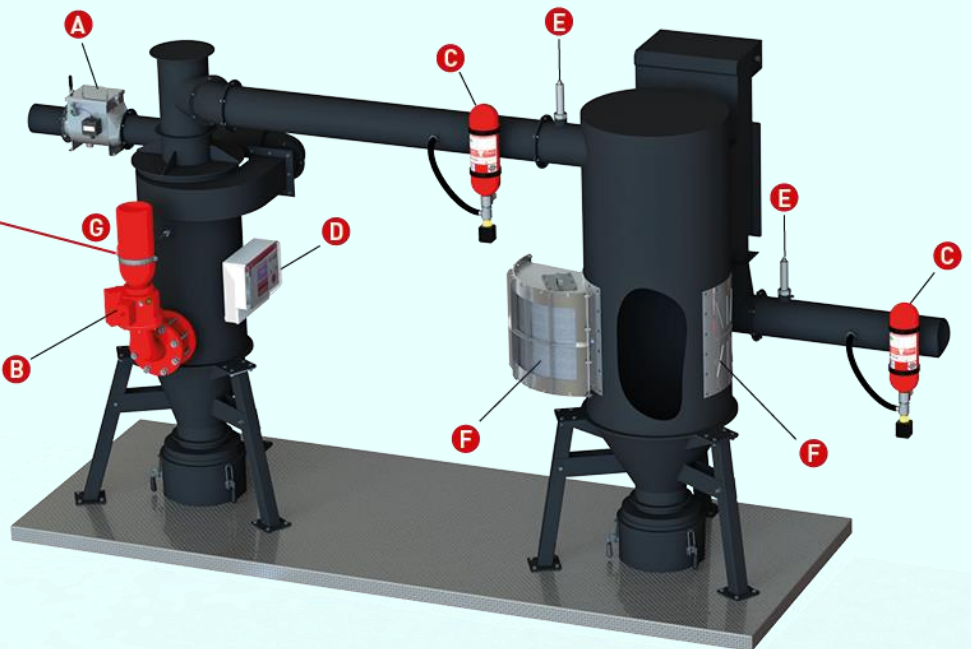

IV

OUR SERVICES

INSPECTION



CONSULTANCY



MAINTENANCE



REPAIR AND
INSTALLATION



OUR RANGE OF APPLICATION

- ✓ Humidifier/ Dehumidifier
- ✓ Fan/ Electric Heater
- ✓ Heat Recovery Wheel/ Plate Heat Exchanger/ Heat Recovery ventilator
- ✓ Blast valve/ Blast door/ CBRN Filters/ Bullet proof window
- ✓ Fire damper/ Gas tight damper
- ✓ Explosion vent/ Flameless Explosion vent/ Explosion Isolation Valve
- ✓ Air conditioner system – Mitsubishi/ Tica/ Temperzone
- ✓ Air treatment Unit/ Center vacuum cleaner/ Galley Hood





SEIBU GIKEN CO. LTD (www.seibu-giken.com)

A leading international manufacturer of heat recovery wheel in the world.

3108-3 Aoyagi, Koga City, Fukuoka, 811-3134 Japan

Tel: (81) (92) 9423511

Fax: (81) (92) 9423761

TEMET

TEMET OY (www.temet.com)

Temet is the global leader in blast protection and special ventilation technology applied in protective constructions such as civilian shelters and hardened military facilities.

Asentajankatu 3, FIN-00880 Helsinki, FINLAND

Tel: +358 20 757 9510

Fax: +358 20 757 9515



CONDAIR PLC (www.condair.co.uk)/(www.condair.vn)

Condair is the world's leading manufacturer of commercial and industrial humidification and evaporative cooling products and systems.

Artex Avenue, Rustington, Littlehampton, West Sussex, BN16 3LN, United Kingdom

Tel: +44 (0)1903 850 200

Fax: +44 (0)1903 850 345

Halton

OY HALTON GROUP LTD. (www.halton.com)

HVAC solution for Oil & gas Industry and Marine, safety is the number one factor.

Esterinportti 2, 00240 Helsinki, FINLAND

Tel: +358 (0)20792 200

Fax: +358 (0)20792 2050

HOLTOP

HOLTOP (www.holtop.com)

HOLTOP, make air handling healthier, more comfortable, more energy efficient

Room 2-1108 Industrial Plaza, Tian An Hi-Tech Ecological Park, No. 555 Panyu Ave, Panyu District, Guangzhou, China

Tel: 86-20-39388201 / 39388463

Fax: 86-20-39388202



RSBP spol.s r.o (<https://www.rsbp.cz/en>)

At RSBP, we are devoted to fire and explosion protection since 1992.

Pikartská 1337/7, 716 00 Ostrava-Radvanice, Czech Republic.

Tel: +420 596 252 170



EXPANSION ELECTRONIC (www.expansion-electronic.eu)

Leader in the production of electrostatic technology filters for HVAC and rooftop.

Via delle Industrie, 18 · 36050 Cartigliano (VI), ITALY

Tel: +39 0424 827058

Fax: +39 0424 827061

LIFAair®

LIFA AIR (<https://lifa-air.com>)

Air purification experts from Finland.

Rajamaankuja 6, 02970 Espoo, Finland

Tel: +358 9 394 858

VI OUR PROJECTS



IMEXPHARM PHARMACEUTICAL FACTORY
HO CHI MINH CITY

Scope of supply: Sensible heat recovery wheel Seibu Giken
For production area



DUNG QUAT OIL REFINERY PLANT
QUANG NGAI PROVINCE

Scope of supply: Blast valve Temet
For main control room



CA MAU GAS PROCESSING PLANT
CA MAU PROVINCE

Scope of supply: Blast door Temet
For main control room



MIEN DONG INTERNATIONAL GENERAL HOSPITAL
BINH DUONG PROVINCE

Scope of supply: Heat recovery wheel Seibu Giken



NGHI SON OIL REFINERY PLANT
THANH HOA PROVINCE

Scope of supply: Condair humidifier
For production area



OLAM ALMOND BIEN HOA FACTORY
DONG NAI PROVINCE

Scope of supply: Sensible heat recovery wheel Seibu Giken
For production area



TOPCAKE CONFECTIONARY
LONG AN PROVINCE

Scope of supply: Air handling unit (AHU) and air-cooled chiller TICA for production area



SUNRISE BAY NOVALAND
DA NANG CITY

Scope of supply: Heat recovery wheel Seibu Giken
For cruise ship



II-VI VIETNAM FACTORY
BINH DUONG PROVINCE

Scope of supply: Air-cooled mini chiller TICA
For production area



**HO TRAM STRIP
VUNG TAU CITY**

Scope of supply: Humidifier Condair for herbal storage



**FANG BROTHER FACTORY
TAY NINH PROVINCE**

Scope of supply: Heat recovery wheel Seibu Giken



**AN HOA PULP FACTORY
TUYEN QUANG PROVINCE**

Scope of supply: Water-cooled package TICA and spare parts



**MELIA HOTEL
KHANH HOA PROVINCE**

Scope of supply: Heat recovery wheel Seibu Giken



**SALA OFFICE IIA
HO CHI MINH CITY**

Scope of supply: Heat recovery wheel Seibu Giken



**XANH PÓN HOSPITAL
HA NOI CITY**

Scope of supply: HVAC Control system



**PEARL PLAZA (SSG TOWER)
HO CHI MINH CITY**

Scope of supply:
Heat recovery wheel Seibu Giken
for office area



**NOVOTEL SONG HAN HOTEL
DA NANG CITY**

Scope of supply:
Heat recovery wheel Seibu Giken
For office area

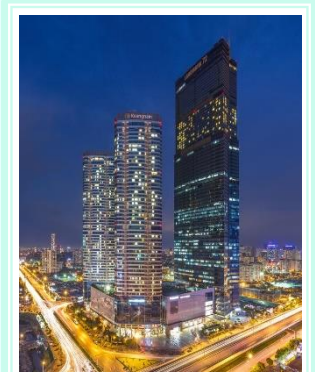

**LAND MARK 72 BUILDING
HA NOI CITY**

Scope of supply:
Plate Heat Exchanger Holtop



**THE SUPREME PEOPLE'S COURT - VINHOMES
HA NOI CITY**

Scope of supply: Condair dehumidifier



**TAY HO VIEW
HA NOI CITY**

Scope of supply: Condair dehumidifier



**LONG SON PETROCHEMICAL
BA RIA VUNG TAU PROVINCE**

Scope of supply: TEMET Blast valve



**PARKER PROCESSING VIETNAM
THANG LONG IP, HA NOI CITY**

Scope of supply: Condair humidifier



**INTERSNACK CASHEW
TAY NINH & LONG AN PROVINCE**

Scope of supply: Condair humidifier



**PV DRILLING
VUNG TAU CITY**

Scope of supply: Halton fire & gas damper



**FPT FORNIX DATA CENTER
HA NOI CITY**

Scope of supply: Condair humidifier



**NATIONAL ARCHIVE CENTER
HA NOI CITY**

Scope of supply: Condair dehumidifier



**APPLE LAB ROOM
HA NOI CITY**

Scope of supply: Condair dehumidifier and humidifier

VII OUR CUSTOMERS



LIN KA SERVICES COMPANY LIMITED

 : Level 5, Songdo Bld, 62A Pham Ngoc Thach Str.,
Vo Thi Sau Ward, District 03, HCMC, Vietnam

 : (84-028) 6682 8478

 : (84-028) 3822 6319

 : <https://www.facebook.com/linka.congty.3/>

 : info@linka.com.vn

 : www.linka.com.vn

www.condair.vn